



● View of completed model



● East face



● South face



● West face



● North face

Japan Kumamoto Castle

Kumamoto Castle, in Japan's Kumamoto prefecture, was constructed in 1607. It is one of Japan's most famous castles.

At the time of construction, ginkgo trees were planted at the site to ensure its residents would have food even during battles, meaning that the castle was also referred to as Ginnan-jo (castle with ginkgo trees).

The castle's circumference was built to be approximately 9km long, with a total area of 980,000m².

The castle has two towers or tenshukaku at the top, which provide views of everything within a great distance of the castle. The bigger tower is 30m high, and the smaller one is 19m high.

The original towers were destroyed in a fire in 1877, and were reconstructed in 1960.

In Japan, Kumamoto Castle is known for its construction which made strategic use of the landscape. The beautiful curves of its stone walls become suddenly steep towards the top, a building technique which made it difficult for enemies to break in.

■ Parts list (Pattern) : Thirteen A4 sheets (No.1 to No.13)

■ No. of Parts : 130

■ Assembly Instructions : Seven A4 sheets (No.1 to No.7)

* Build the model by carefully reading the Assembly Instructions, in the parts sheet page order.

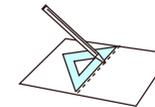

★ Hint: Trace along the folds with a ruler and a used pen (no ink) to get a sharper, easier fold.

Assembly Instructions

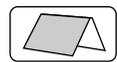

----- Mountain fold (dotted line)
● Make a mountain fold.

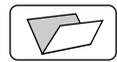

- - - - - Valley fold (dashed and dotted line)
● Make a valley fold.

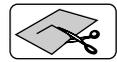

———— Scissors line (solid line)
● Cut along the line.

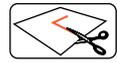

———— Cut in line (solid line)
● Cut along the line.

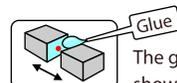

The glue spot (colored dot) shows where to apply the glue.

● Glue spot (Red dot)
Glue parts with the same number together.

● Glue spot (Green dot)
Glue within the same part.

● Glue spot (Blue dot)
Glue to the rear of the other part.

Tools and materials



● Scissors, set square, glue (We recommend stick glue), pencil, used ballpoint pen, tweezers, (useful for handling small parts)

Assembly tip



● Before gluing, crease the paper along mountain fold and valley fold lines and make sure rounded sections are nice and stiff.

Caution



● Glue, scissors and other tools may be dangerous to young children so be sure to keep them out of the reach of young children.

Before starting.

- There is a sheet number (No.1 to No.13) printed at the bottom center of each Pattern page. Assemble the model in the order of the page numbers. (*Assembly parts are on sheets No. 2 to No. 13.)
- There are a total of 130 parts and each sheet carries a parts symbol. The 'glue spot' on each part bears the number of the part to which it should be glued.
- The numbers ①②③, etc., on each part indicate the order in which they are to be glued.
- Where there are multiple joints within a single part, or 'glue spots' where the part is to be glued to another, there are colors ●●● and numbers to give detailed instructions as to the correct positions.

Sheet No.2

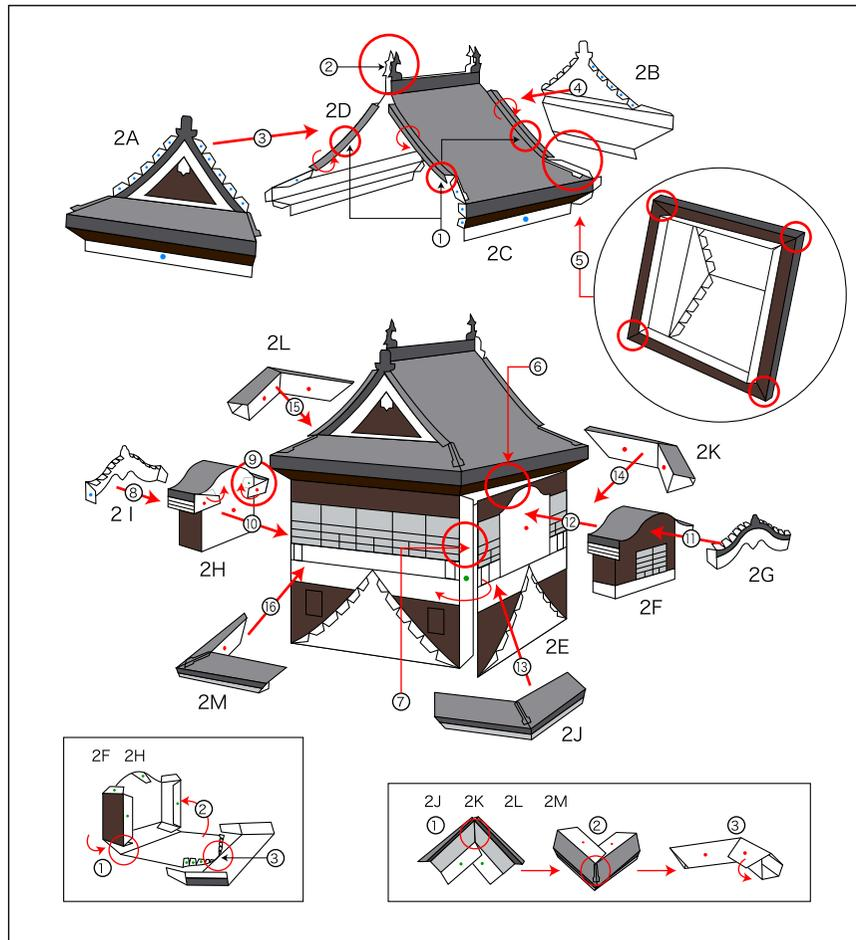

Sheet No.3

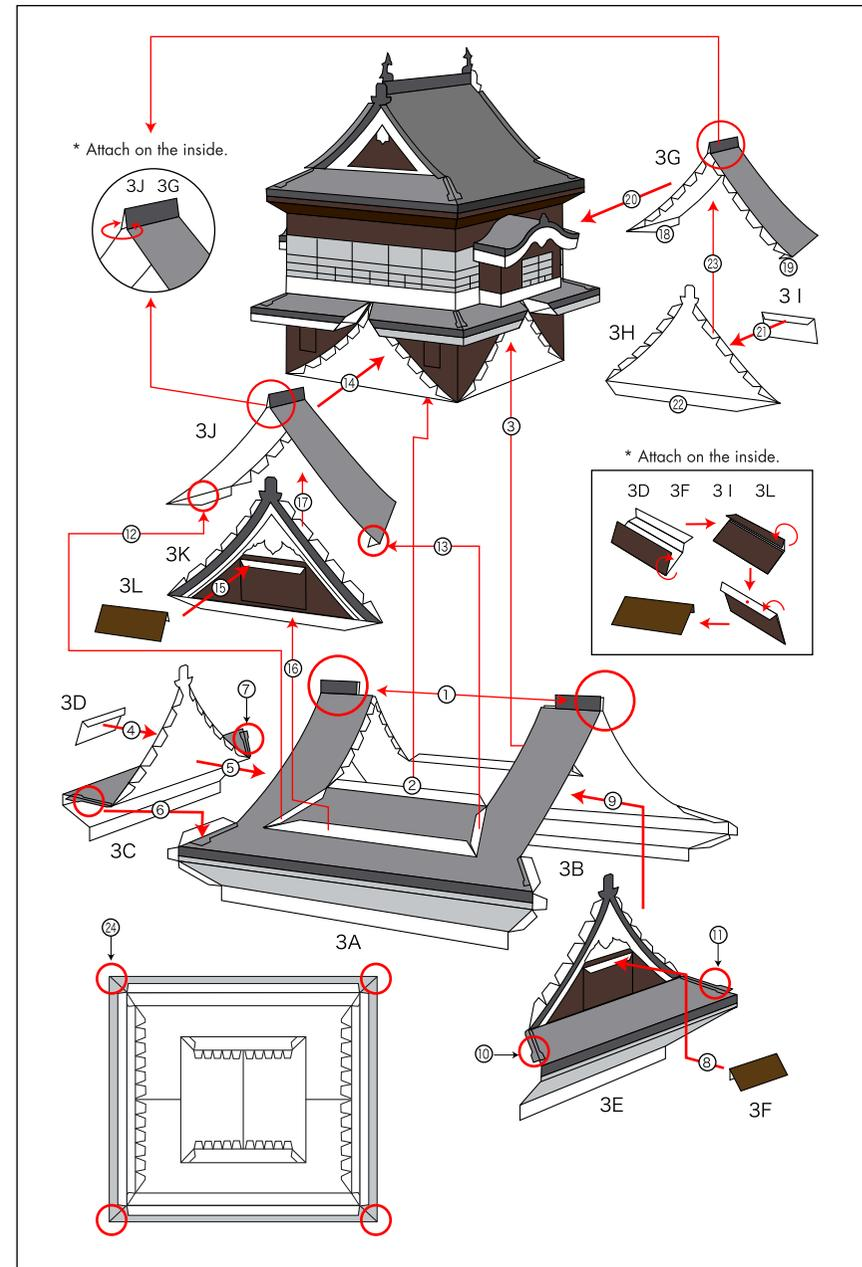

Sheet No. 6·7

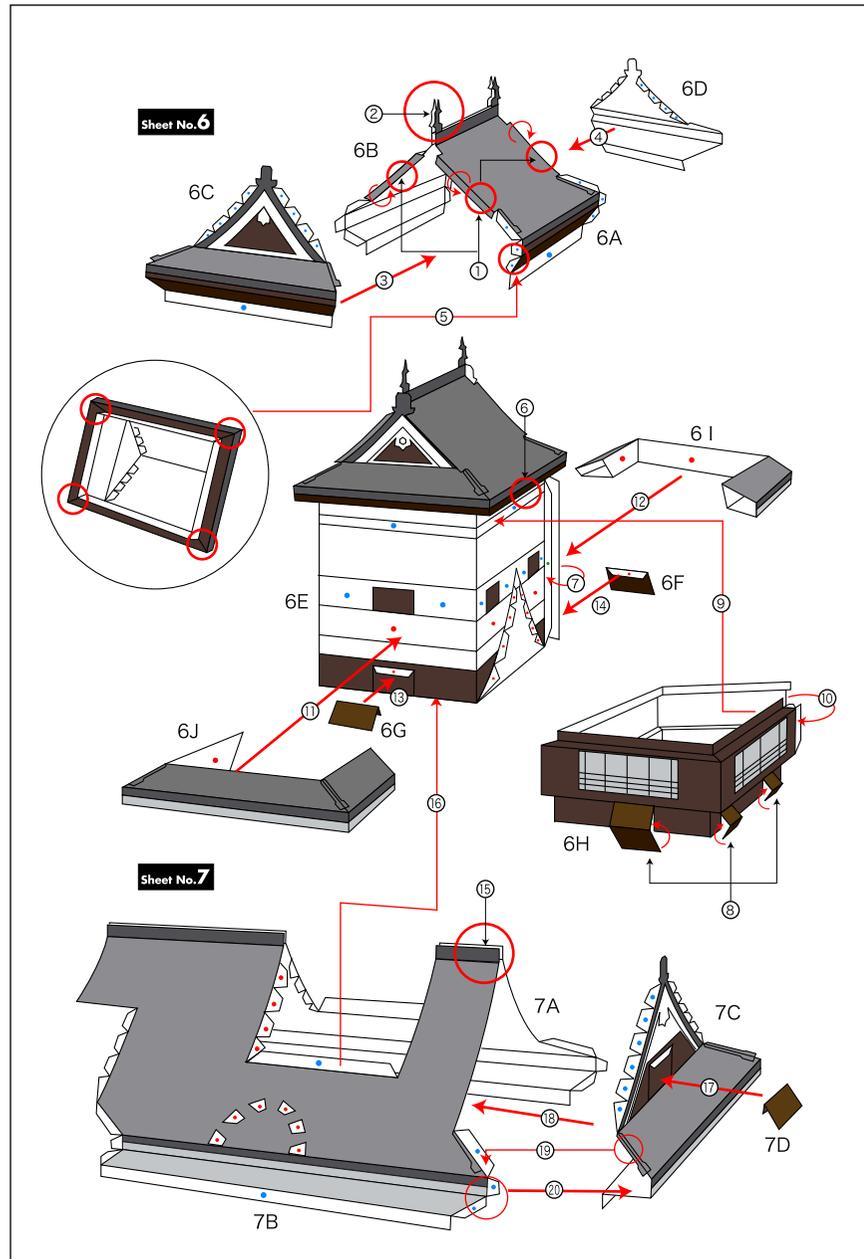

Sheet No. 7·8

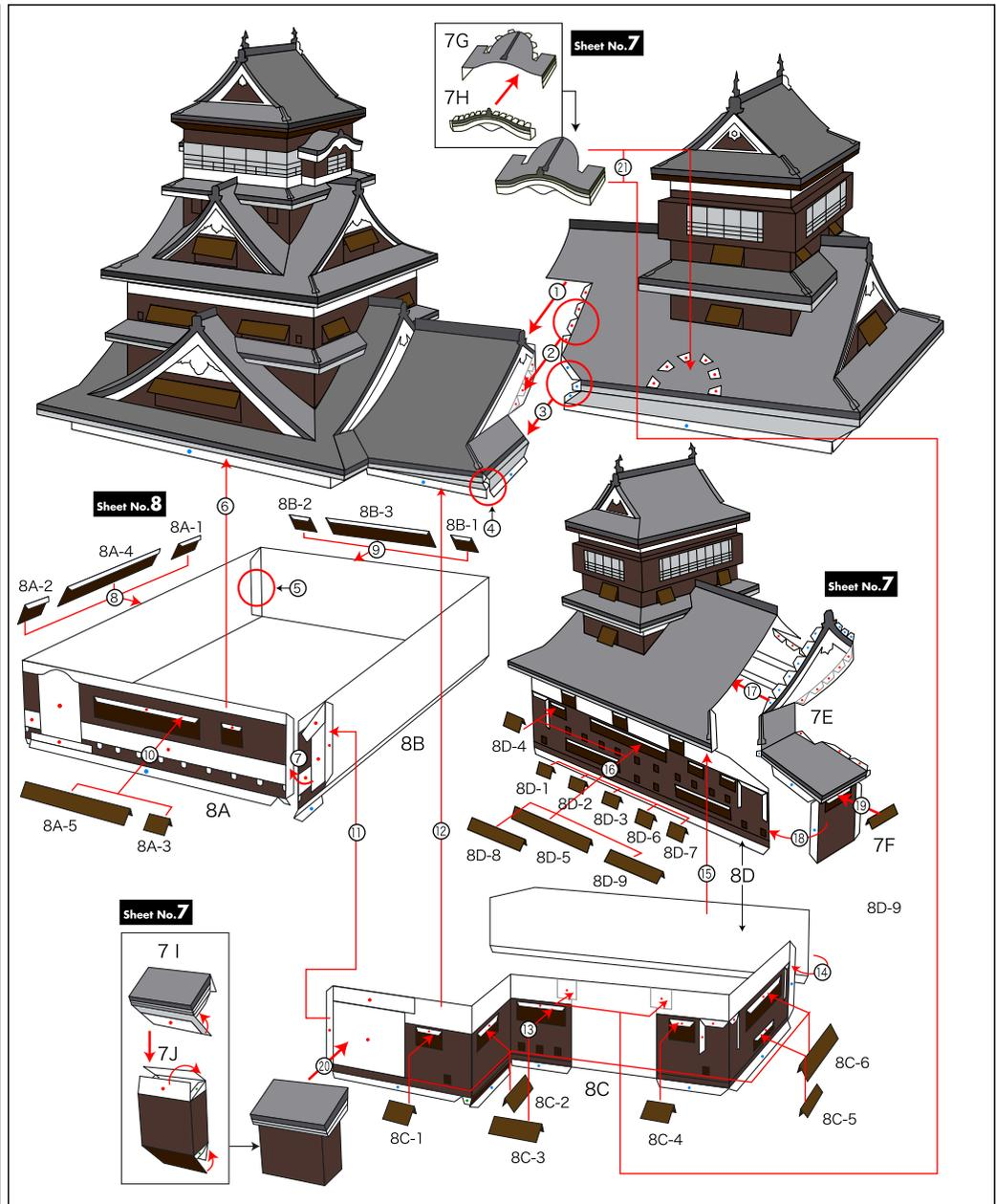

Sheet No. 9·10

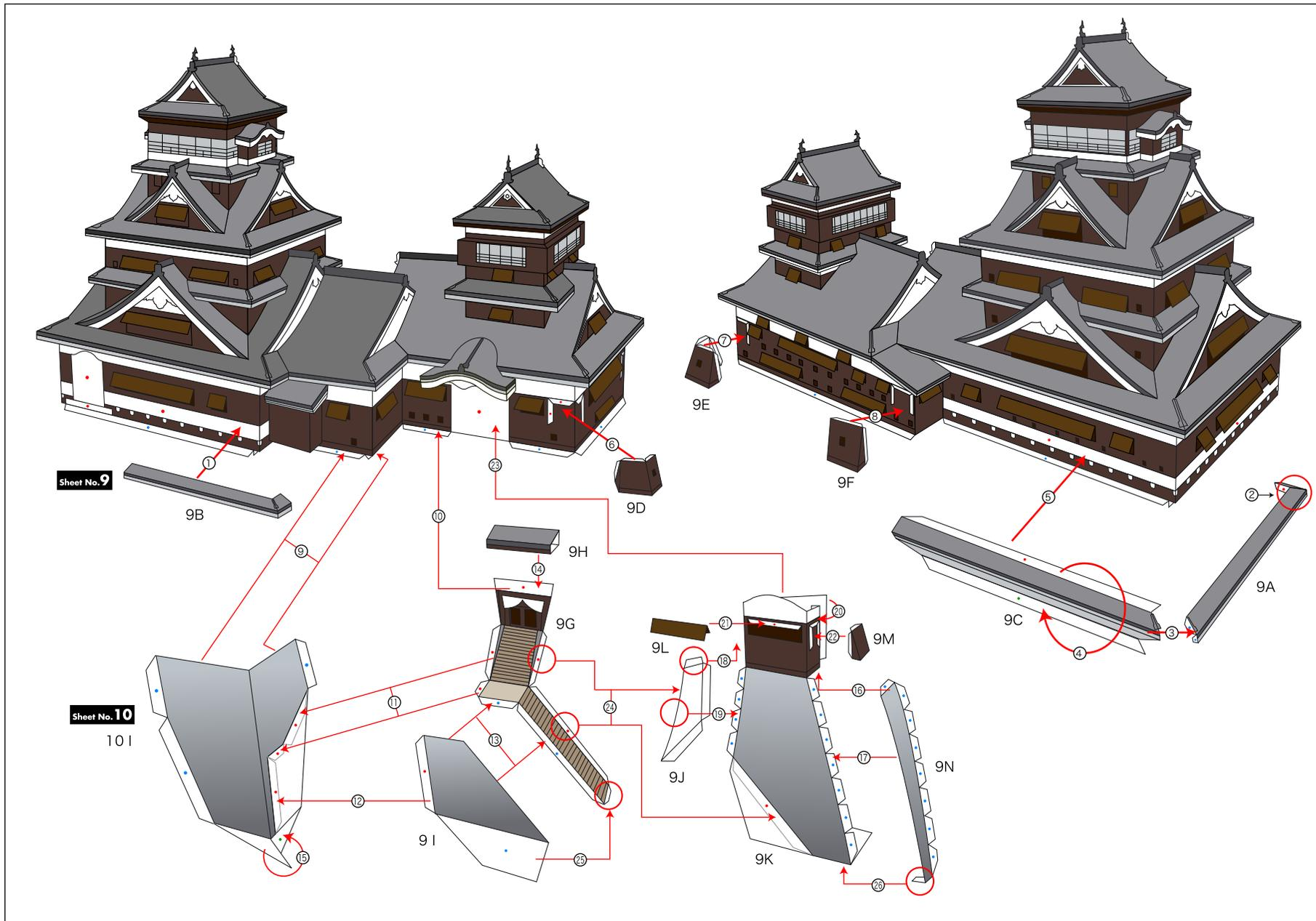

Sheet No. **10·11·12**

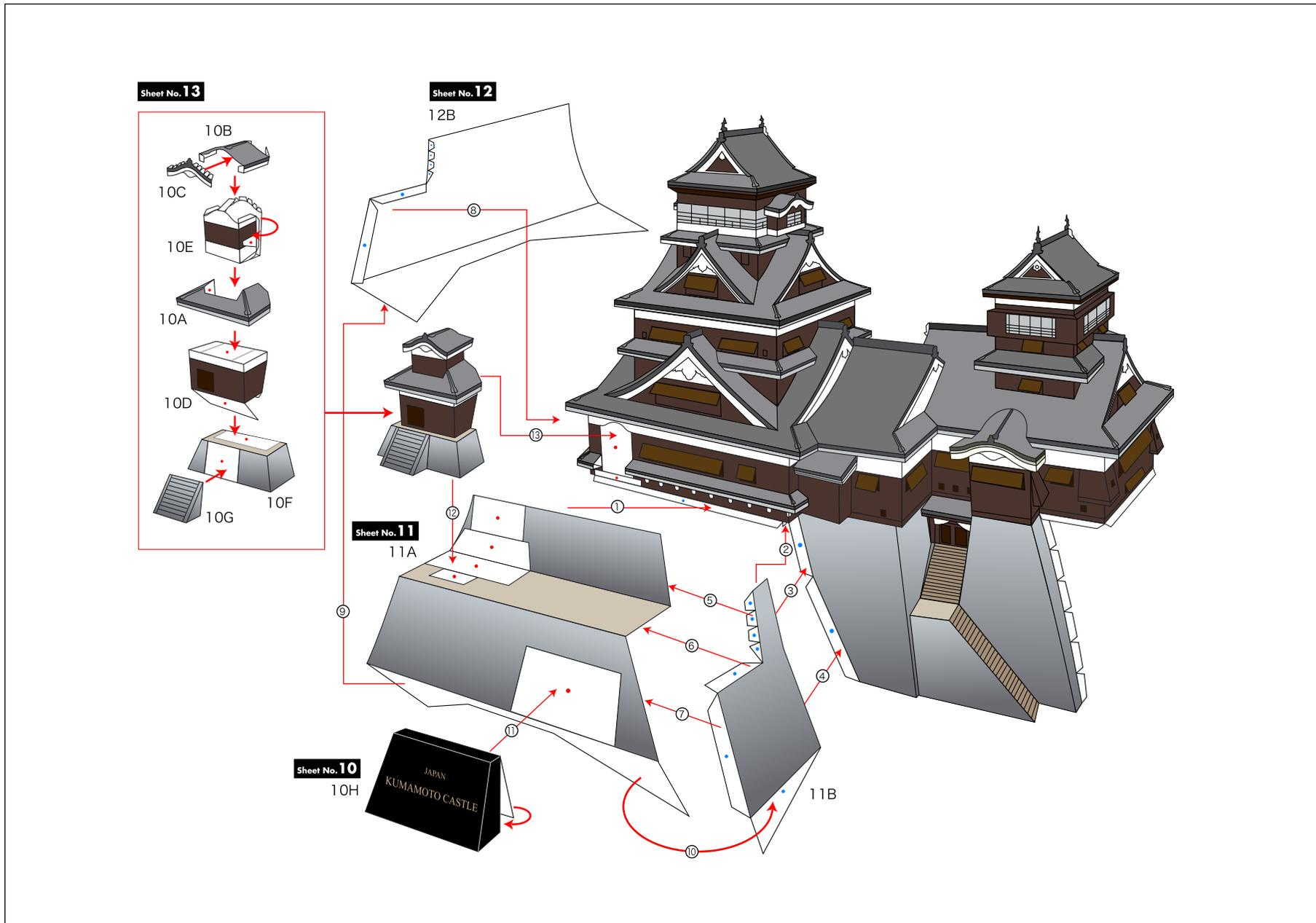

Sheet No. 12·13

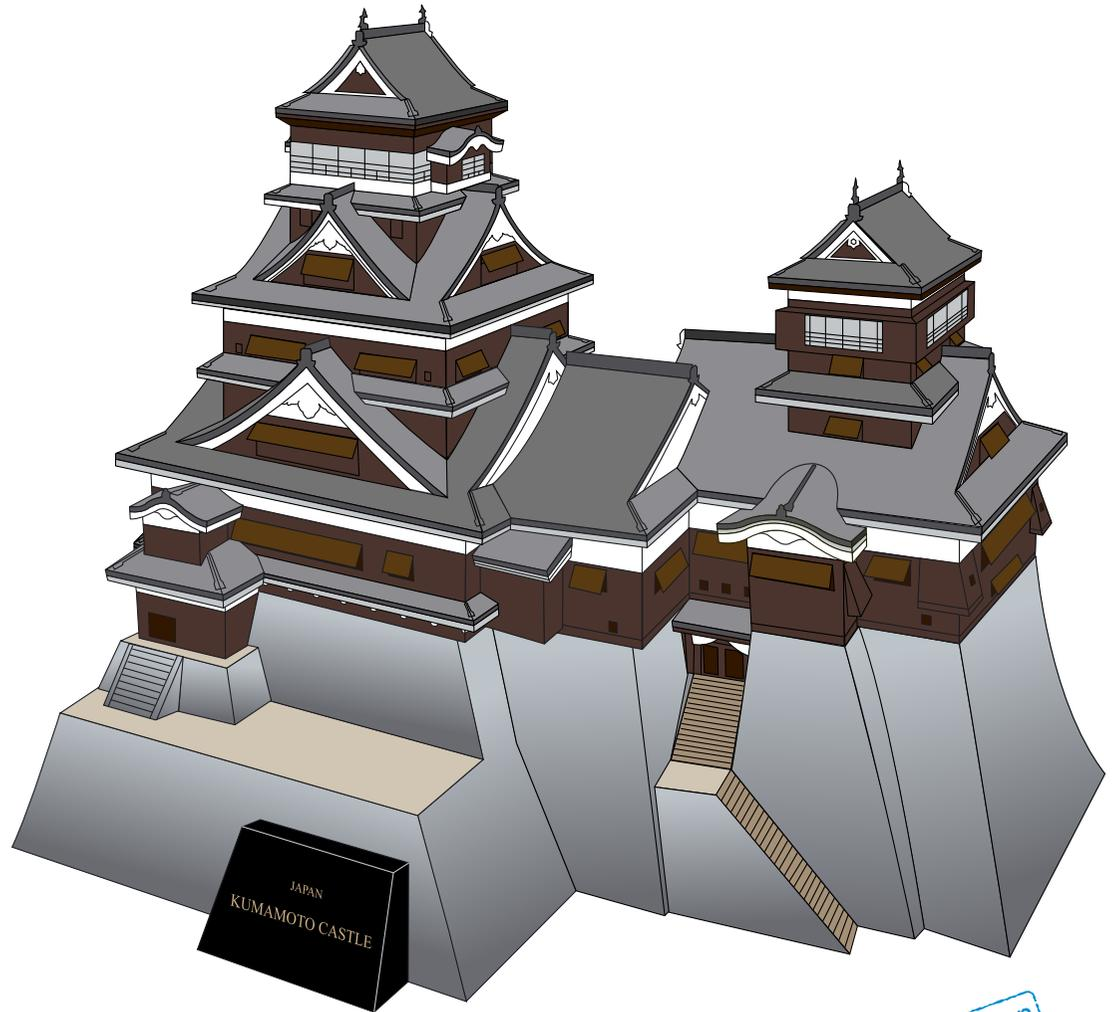
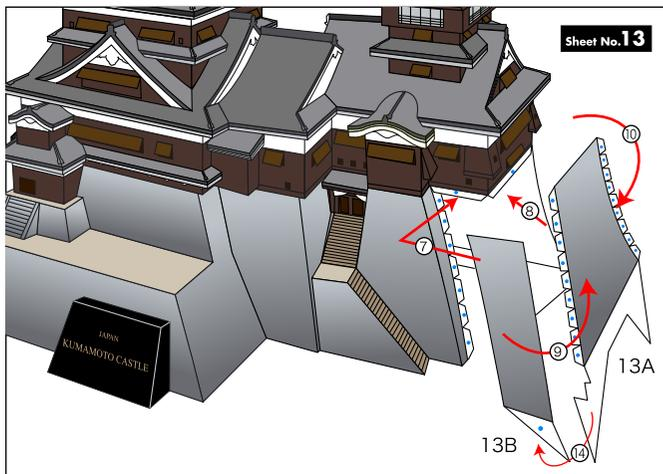
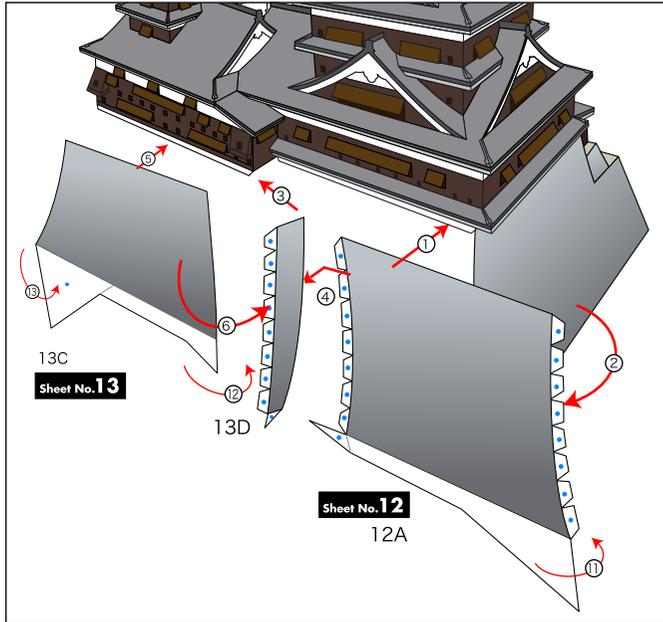

Completion